

INSTALLATION INSTRUCTIONS

E76 SERIES STANDALONE ELECTRONIC LOCKSET



- Keypad Programmable
- 3,000 Users, 32 Temporary Users
- 4 to 6 digit PIN Codes
- 3 Passage Mode Option
- 32 Access Groups, Schedules
- 32 Holidays
- 4 Authority Levels
- Keypad Tamper Lockout
- Mechanical Key Override
- Battery Powered (4AA)
- Blue Backlit Cast Metal Keys
- Weather & Vandal Resistant
- Retrofit existing Lock Door Prep
- Electrified SDC Mortise Lockcase
- Heavy Duty ANSI Grade 1
- Vandal resistant Lever Handles

Place E76 Template on inside of door to mark and drill hole locations and mortise cut out.

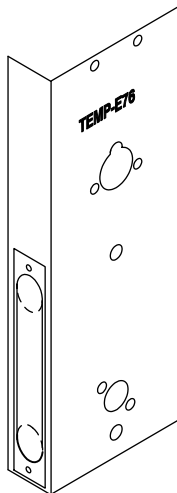

After drilling holes in door, use a 1/4" Butterfly bit, to drill the wire raceway where shown.

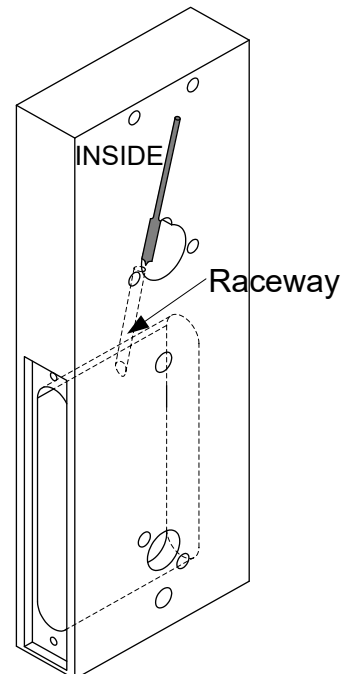

1 Pass the wires from the lockcase through the raceway hole. Lightly pull the wires through as you pass the lockcase into the mortise cut out.

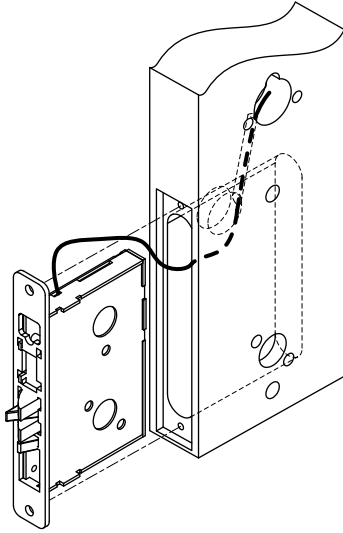

2 Install the Mortise lockcase. (Refer to lockset instructions)

3 Install the Keypad and Battery pack to the door

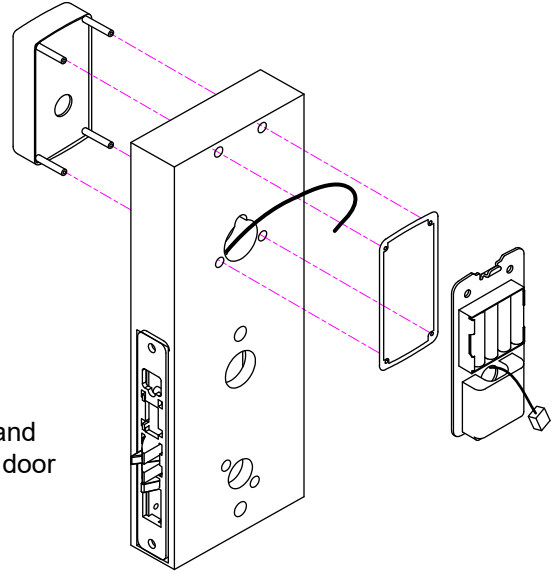

4 Plug in the keypad to the battery pack. Attach wires from the lockset to the keypad using the chart below.

Function	Keypad	Lockset
Motor +	RED/WHT	RED
Output -	WHT/BLK	WHT
REX (C)	BLK	WHT/RED
REX (N/C)		ORG/RED
REX (N/O)	BLU	YEL/RED

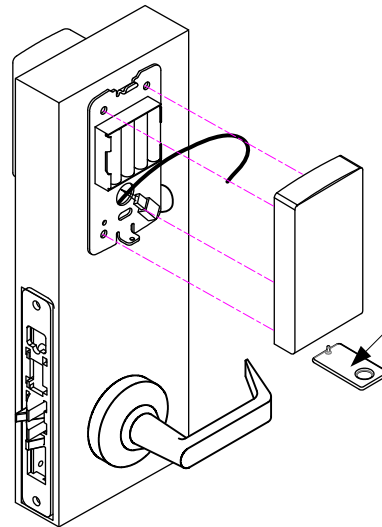

NOTE:
Use E75-TOOL to remove back cover to replace batteries.

Specifications

- Power** 4AA Batteries (Alkaline only) or External 12VDC Power @ 30mA
- Inputs** 1 Request-To-Exit
1 Door Position Switch
- Output** SPDT Contacts 1A @ 30VDC Relay
- Temperature** -20° F to +130° F (-30° C to +54° C)
- Humidity** 5% to 95% non-condensing
- Latch Bolt** 3/4"
- Backset** 2-3/4"
- Strike** 4-7/8" ANSI A115.2
- Door Thickness** 1-3/4" to 2-1/8"

Additional Wire Connections

- 12VDC Ext Power In = RED(+) / BLK(-)
- Request-To-Exit = BLU(N/O) / BLK(COM)
- Door Position Switch = GRY(N/O) / BLK(COM)
- Auxiliary Relay = ORG (N/C)
WHT(COM)
YEL(N/O)
- System Reset = BRN / BRN





















Quick Start Programming Instructions E76 EntryCheck™

Lock Initiation

When the lock is first installed or when after a hard reset has been performed, the E76K must be initialized and a lock ID must be entered before you will be allowed to enter the program mode.

To test lock operation before initialization, enter ***741**. This temporary code will unlock the E76K for testing purposes. Once a lock initialization has been performed, this code is no longer active until a hardware reset is performed which will erase all the users and return the E76K back into the uninitialized factory default condition.





To Initialize Lock:

- 1) Apply Power (Plug in the battery pack)       
- 2) Press #9* 123456# 0001#    
- 3) Press **#       

The above example enters a Lock ID of 0001. If Multiple locks are used with the Management Software, Each lock must have it's own *Unique* Lock ID (0002, 0003 etc)













User Programming

Enter Programming Mode: #9# User No# User PIN

1) Press #9# 01# 123456#     

User 01 is the administrator and has full programming rights. 20 seconds of inactivity will automatically return you from programming mode you to operational mode.

Add a User: 01# User No.# PIN Code # Pin Code # Group No.#

Example: Press 01#   04#   5555#   5555#   06#    

You have just added User #04 with a PIN of 5555# to unlock the door.

User 4 has also be assigned to group 06 (24/7 access).

User must be assigned a 4 to 6 digit PIN code.

Add a Card: 06# User No.# Present Card





Example: Press 06#   04#   Present Card #      

You have just added a card as User #4.





User 4 has also be assigned to group 06 (24/7 access).

**Prox Units
Only**





Set Entry Mode : 05# Mode

Example 1: Press 05#   1#  

Unlock the door either by entering a (PIN + #) or presenting card.

Example 2: Press 05#   2#  

Unlock the door by presenting a valid card.

Example 3: Press 05#   3#  

Unlock the door by presenting card plus the associated user (PIN +#).

Mode = 1 PIN or Card (default)
2 Card Only
3 Card and Pin







Change a User PIN Code: 03# User No.# New PIN Code # New Pin Code

Example: Press 03#   05#   1220#   1220#    

You have just Changed User #05's Pin code to 1220

The Administrator's PIN code must be 6 digits in length. All other PIN codes may be 4-6 digits in length

Delete a User: 02# User No.#

Example: Press 02#   04#    

You have just Deleted User #04

Exit Programming Mode: **#

Press **#       



Additional E76 Programming

Change a User Group: 04# User No.# New user Group

Example: Press 04# 05# 02#

You have just Changed User #05's group to Group 02.

Enable a User: 26# User No.#

Example: Press 26# 04#

You have just re-enabled User #04 .

Disable a User: 27# User No.#

Example: Press 27# 04#

You have just disabled User #04 . It re-enable this user, use Function 26

Set Unlock Timer: 21# Seconds#

Example: Press 21# 03 #

Seconds = 03-20

Unlock timer is set for 03 seconds. (default)

Beep on Key Press : 62# Status

Example 1: Press 62# 1#

Status = 0 Disabled

The E76K will beep each time you press a key.

1 Enabled (default)

Set the Date: 30# MMDDYY#

Example: Press 30# 011513 #

The date is set for January 15 th 2013

MM = 2 digit Month

DD = 2 digit Day

YY = 2 digit Year

Set the Time: 31# HH MM#

Example: Press 31# 1320 #

The time is now set to 1:20 PM.

HH = Hours (24hr format)

MM = Minutes (24hr format)

Clear all Programming : 99# 000000

Example 1: Press 99# 000000 #

All user codes and programming is erased and settings are set to factory defaults. Lock initialization and Lock ID are not cleared.

Resetting the E76 to Factory Settings

Warning!! This procedure will perform a hardware reset and will erase all the users and custom settings returning the E76K back into the uninitialized factory default condition.

- 1) Remove power (Unplug the battery pack)
- 2) Short and hold the 2 Brn reset wires together
- 3) Apply power. (Plug in the battery pack)



The LED will Flash Red/Grn light during the initialization process. When initialization is complete, you will hear 3 beeps.

- 4) Remove power (Unplug the battery pack)
- 5) Disconnect and insulate the Brn Reset wires.

To test lock operation after a Hardware Reset and before initialization, enter *741. This temporary code will unlock the E76K for testing purposes. Once a lock initialization has been performed (see page 1), this code is no longer active until a hardware reset is performed again.

